



Spett.le

Data

Luogo e Via

Cap

Prov.

Riferimento

Preventivo

Ordine

### SCHEDA CONTROTELAIO STH PRO

PAG.1

POS.	PZ	L (mm)	H (mm)	MOTORE CINGHIA	DX SX	BAT. <b>A</b>	TIPOLOGIA AVVOLGIBILE	COLORE AVV.	NOTE
<input type="checkbox"/> Assemblaggio controtelai <input type="checkbox"/> Montaggio avvolgibile nel cassonetto									

#### CASSONETTI

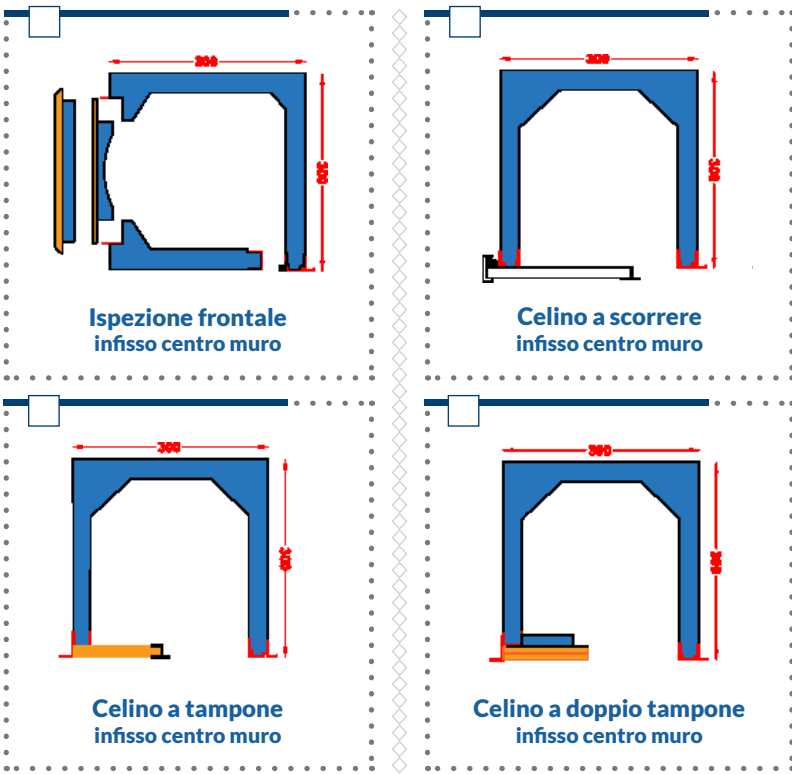

#### RIFERIMENTO MISURE

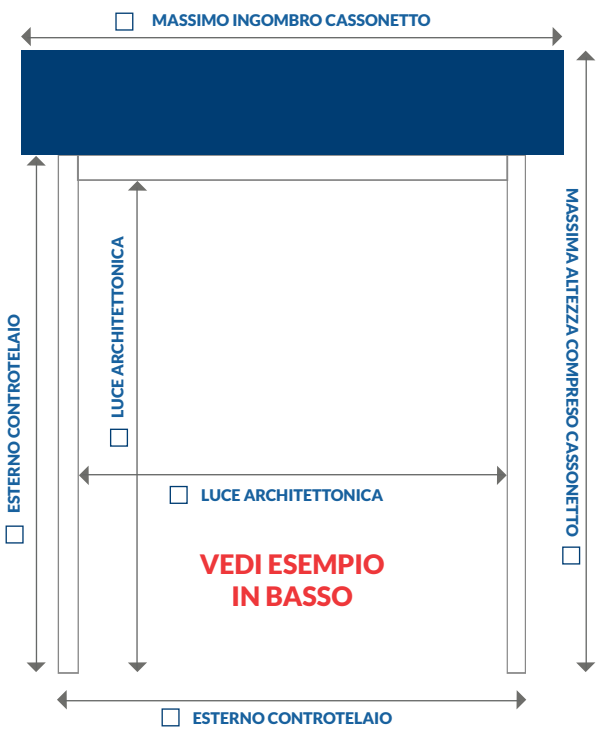

#### ACCESSORI PER CONTROTELAIO

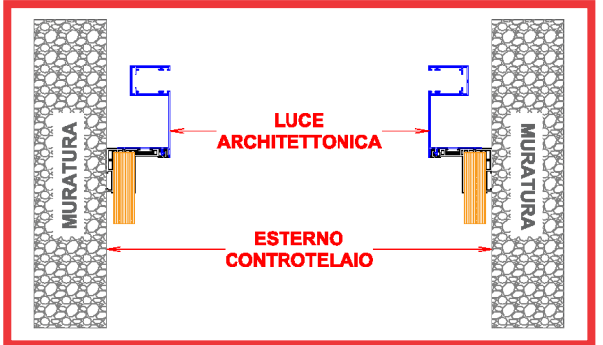
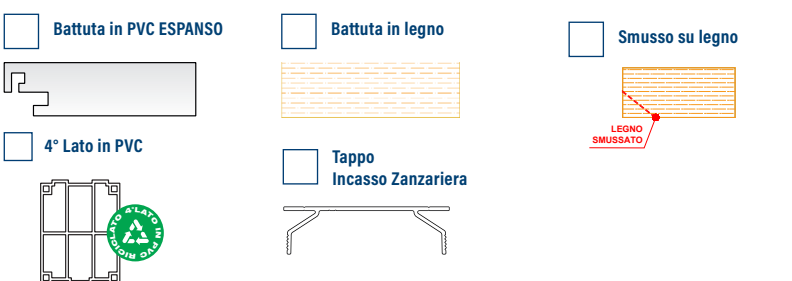

**NOVITÀ**

**FGOGCP** IN PVC

**FGOGC** IN ALLUMINIO

**VARIANTI**

EPS PER MURATURA

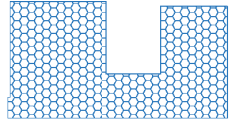

EPS PER STIPITI

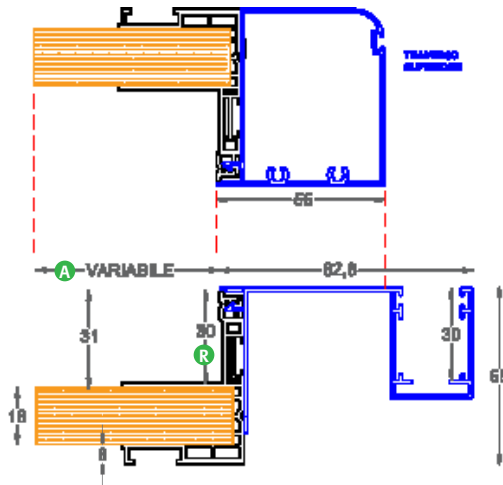
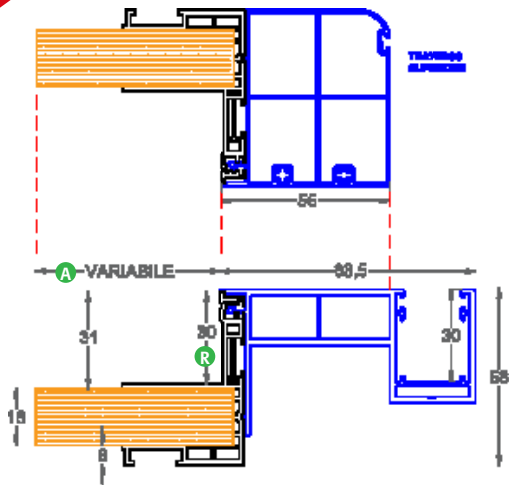
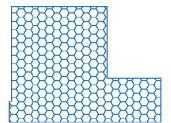

**FGOIG**

**FGOG**

**VARIANTI**

**DISPONIBILI PER CONTROTELAI**

**FGOIG**

**FGOG**

**FGOI**

**FGOS**

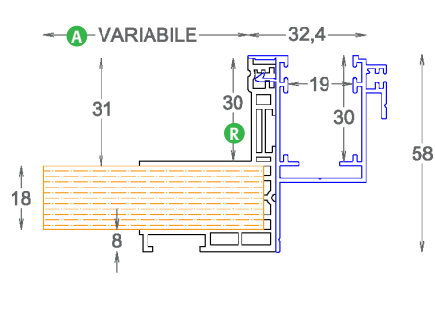
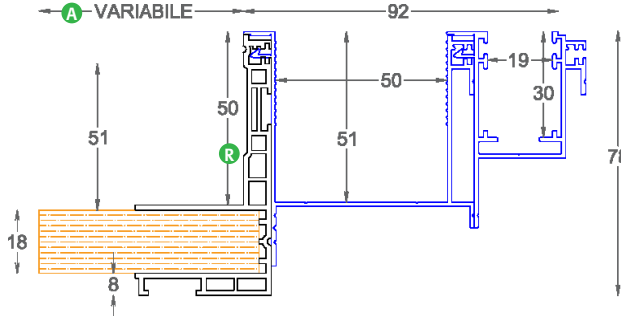

RETE PORTA INTONACO

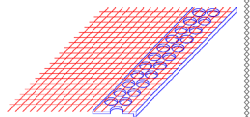

PROFILO T IN ALLUMINIO

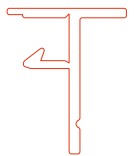

**FGOI** CONTROTELAIO SINGOLO

**FGOS** CONTROTELAIO SINGOLO

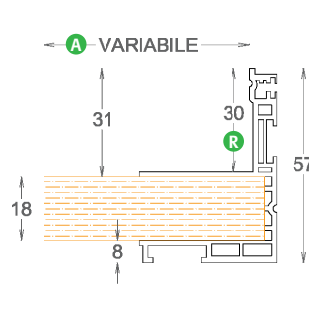
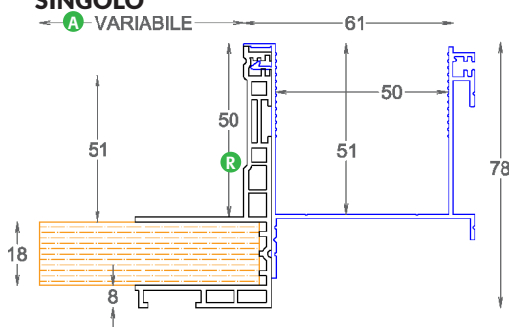

**RIBATTUTA**

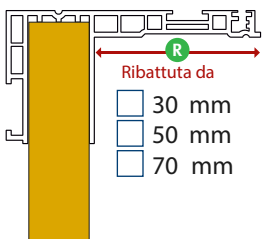

- Ribattuta da
- 30 mm
  - 50 mm
  - 70 mm

**Per il PROIG e PROI la ribattuta è di standard da 50 mm**

**Cartella colori profili in alluminio Sth Pro**

Bianco 9010 01 (RAL)	Verde 22 (RAFF.)	Marrone 23 (RAFF.)	Grigio 24 (RAFF.)
Argento 02 (RAL)	Avorio 1013 19 (RAL)	Renolit Chiaro 37 (LEGNO)	Renolit Scuro 39 (LEGNO)

**Cartella colori PROGCP in PVC**

Bianco Massa 9016 (PVC)	Avorio Massa 1013 (PVC)	Grigio 7016 (Pellicolato)
Noce Sorrento 16 (Pellicolato)	Golden Oak 23 (Pellicolato)	Noce Venato 27 (Pellicolato)